

Builders
® CHOICE

Full Line Catalog

WOOD DOORS
EXTERIOR & INTERIOR



About OrePac



OUR HISTORY

OrePac is a family-owned and operated business, founded by the Hart family in 1977. Through strong leadership and a commitment to success, the company has grown into one of the premier distributors in the building industry.

Trust, integrity, and a dedication to excellence are the values most important to OrePac. That commitment can be found in the services we offer, the quality of the products we provide, and the way we treat our employees and customers. This dedication to our markets has enabled us to make a positive impact on the shelter industry and the communities we serve.

BUILDERS CHOICE DOORS

Our Builders Choice wood doors come in a wide assortment of species, sizes, and architectural styles to fit your needs. From standard looks to custom designs, our high-quality doors are produced with state-of-the-art machinery at the hands of expert craftsmen. Add curb appeal and value to your home by upgrading the look with a Builders Choice door.

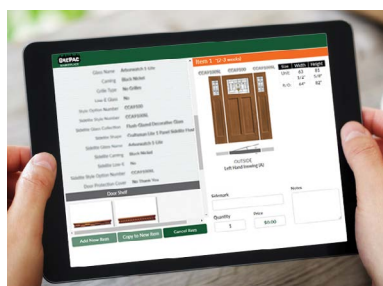
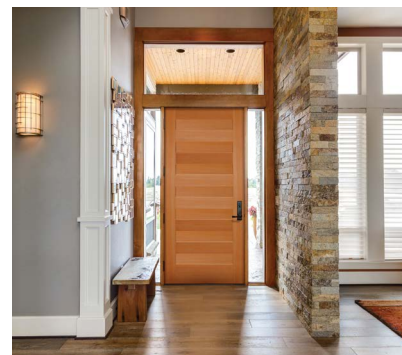

OREPAC MARKETPLACE

At OrePac, our goal is to Make Complicated Simple™. That's why we've created an industry-leading configurator to simplify the door ordering process for our dealers. Talk to your OrePac Sales Representative to find out more about this easy and time-saving tool.

COMPLETE THE LOOK WITH BUILDERS CHOICE MOULDING

We are proud to offer a wide selection of moulding and millwork to complete your home project. Whether you're building a new home, remodeling, or simply updating a room, Builders Choice offers millwork for all professional and DIY applications. Browse our moulding and millwork catalogs to find moulding in architectural profiles and wood species that complement any style of home.



STILE & RAIL COLLECTION Table of Contents



Cover: 4597 shown in fir (see page 21)

Left Top: 4082 with custom sidelites and transom shown in fir (see page 25)

Left Bottom: 20V shown in knotty alder (see page 45)



- 04 ATTENTION TO DETAIL
- 07 EXTERIOR DOOR COLLECTION
 - 08 Contemporary
 - 10 Decorative
 - 14 Craftsman
 - 18 Country Sash & Prairie Mission
 - 20 Clear French
 - 22 Traditional
- 26 INTERIOR DOOR COLLECTION
 - 28 Decorative French
 - 32 Clear French
 - 34 Traditional
 - 40 Traditional Bifolds
- 44 BARN DOORS
- 48 CS CAVITY SLIDER™
- 50 FIRE-RATED
- 54 CUSTOM
- 60 CARE & FINISHING
- 62 WARRANTY

COMPLETE THE LOOK

Attention to Detail

Panel, Sticking & Caming Options

Whether you're looking for a door with sleek contemporary styling or ornate decorative details, it's the panel, sticking, and caming options that complete the look. Although there are no set standards, coordinating the design of your interior and exterior doors provides continuity of style throughout your home.

PANEL

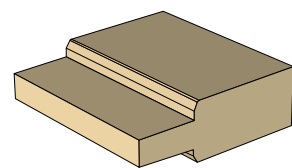

Shoulder

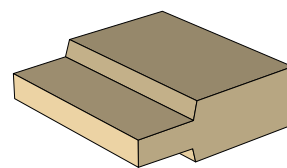

Angle Hip

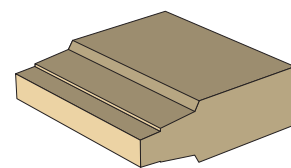

Double Hip

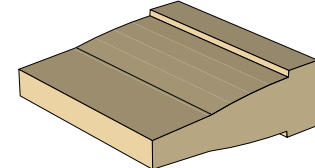

Aspen

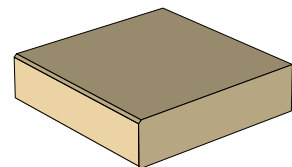

Flat

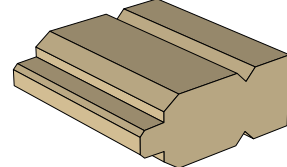

Plank

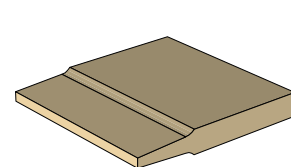

Beveled

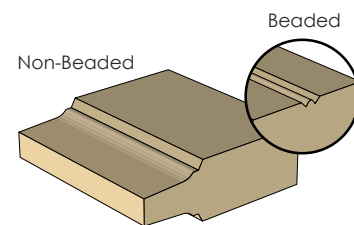

Hip & Hip Beaded

STICKING

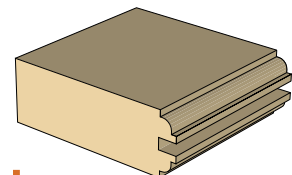

Ovolo

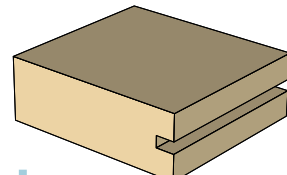

Square

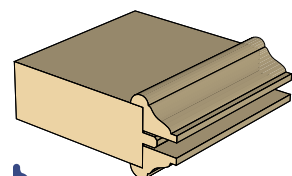

Pinnacle

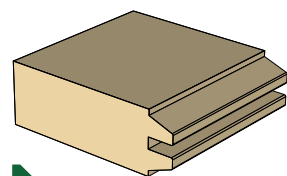

Taper

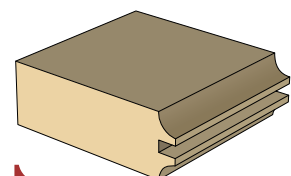

Cove

Sticking Key

Door sticking is indicated with icons in the catalog index. Ask your Sales Representative if you have any concerns about choosing panel and sticking styles for your door.



Door Anatomy

TOP RAIL

Rail located at the top of a door. Rail frame components typically consist of a top, bottom, intermediate, and lock rail.

GLASS LITES

Glass panel within the door frame.

STILE

Upright or vertical components of a stile and rail door.

DOOR PANEL

Wood surface that is framed by stile and rail components. Panels are locked in place within the frame by sticking. Many panel and sticking options are available to complement the style of your home.

DIVIDED LITE BARS

Narrow rabbeted horizontal or vertical frame component that helps create a divided lite unit. These bars can either simulate divided lites (SDL) or be true divided lites (TDL).

INTERMEDIATE RAIL

Horizontal component of a door located above the lock rail and below the top rail.

LOCK RAIL

Rail of the door that meets the stile at the level of the handleset. Usually 36" to center from the bottom of the door.

MULLION

Upright or vertical component dividing panels in a door. Also called a mull.

BOTTOM RAIL

Lowest most horizontal component of a door.

CAMING

Caming refers to the metal banding that joins glass elements together within a decorative door. Choose from the following to create your unique look:



Patina



Zinc



Brass



Pasadena glass shown with Patina caming



EXTERIOR DOOR COLLECTION



08
CONTEMPORARY

Clean lines and geometric door styles designed for bold, modern living.



18
COUNTRY SASH & PRAIRIE MISSION

Classically charming entrances with clean details and room-expanding views.



10
DECORATIVE

Beautifully ornate doors precisely crafted for unique and elegant entrances.



20
CLEAR FRENCH

Graceful and bright entries offering abundant natural light and refined style.



14
CRAFTSMAN

Time-honored architecture meets uncompromising style and exceptional artistry.



22
TRADITIONAL

Timeless first impressions that set the tone and make a sophisticated statement.

Sleek and modern lines join with premium quality and craftsmanship to create our collection of Contemporary wood doors. Whether you are a city dweller or suburbanite, we offer a unique selection of wood doors with clean geometric designs to fit your contemporary style.



4054G | shown in fit

FIR



7026 | Plank



7126 | Plank



4030G



4400 | Flat



4054 | Flat



4054G



4055G



4026 | Flat



4026G



4077G



4077G SL



4077 | Flat



4701 SL

Glass
In-stock glass options vary by style

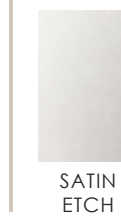

SATIN
ETCH



LOW-E

Multiple sizes, glass, and sticking options available. Contact your Sales Representative for more information.
Doors are shown with clear coat finish (except primed).

Make a welcoming statement from the moment family and friends arrive. Choose from exquisite Decorative door designs crafted from fir, knotty alder, and oak to be paired with elegant glass inserts and complementary sidelites. When it's time to make a big entrance, nothing makes a more unique statement than a Decorative door.

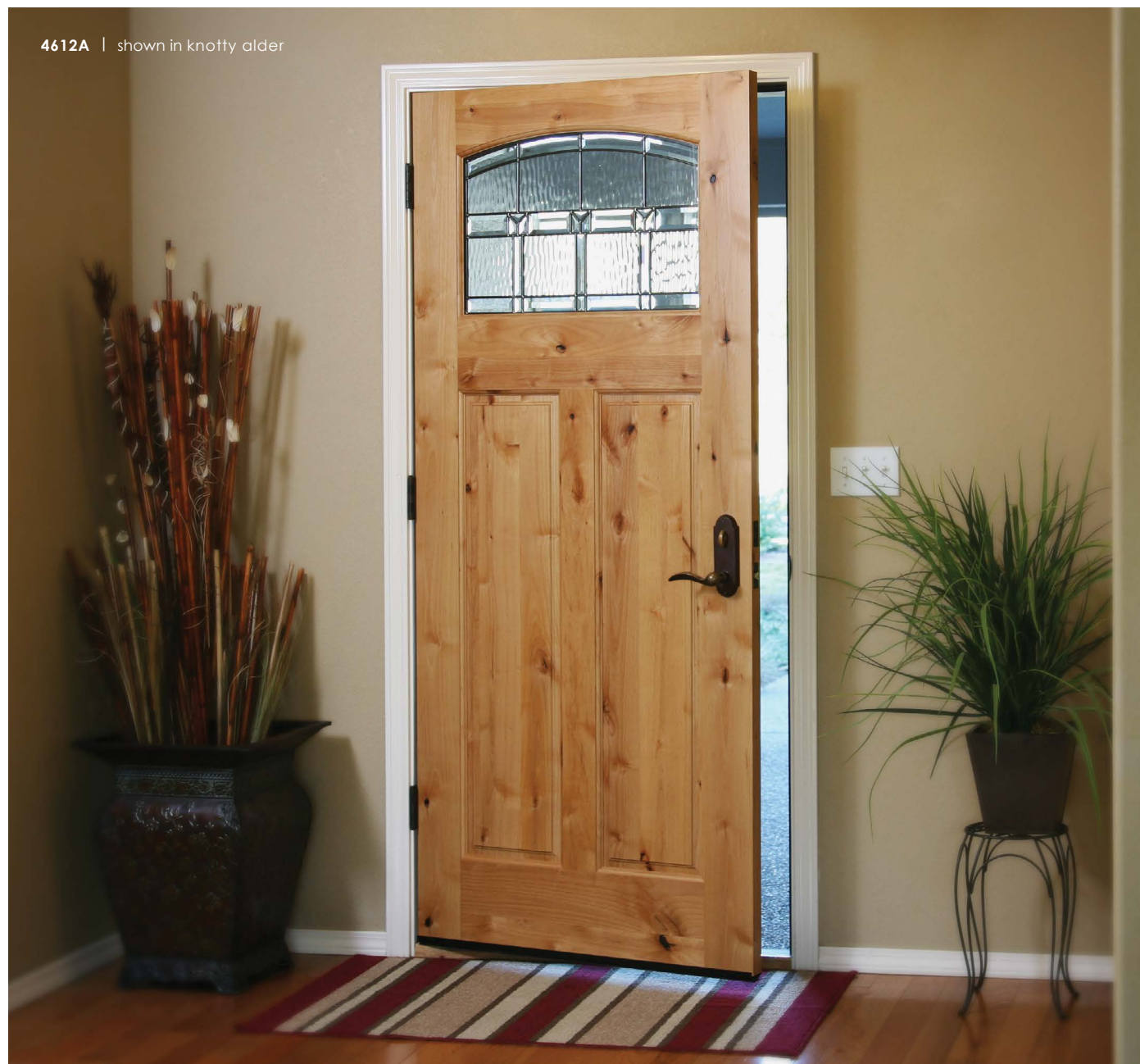

4612A | shown in knotty alder

KNOTTY ALDER

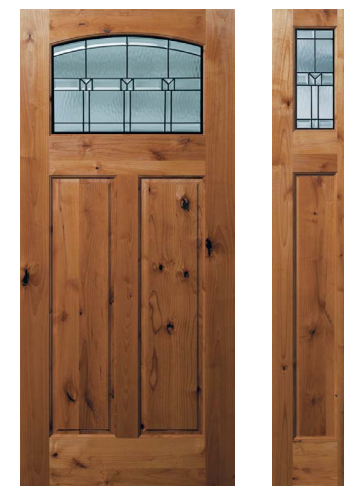

4612A | Raised
TRADITIONS



4612 SL

FIR



4612 | Flat
TRADITIONS



4612 SL



4612 | Flat
PASADENA

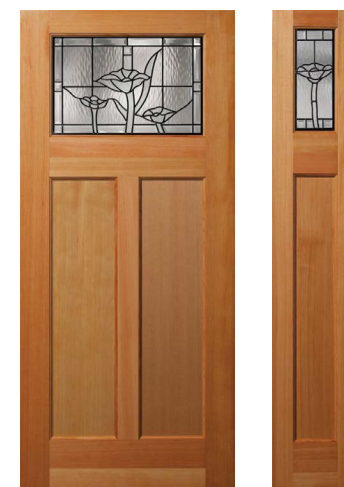

4612 | Flat
POPPIES



4612 SL

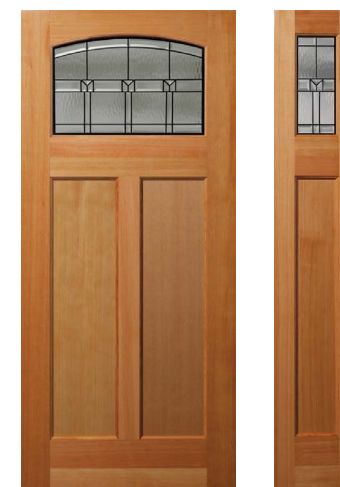

4612A | Flat
TRADITIONS



4612 SL

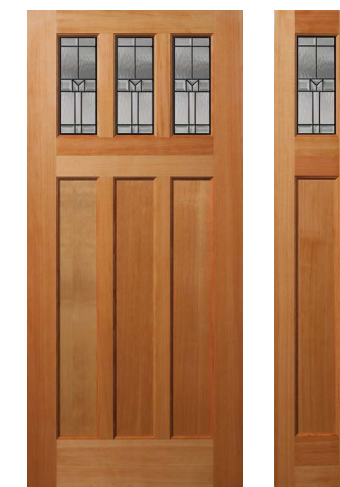

4362 | Flat
TRADITIONS



4612 SL



4462 | Flat
PRAIRIE



4462 SL

Dentil Shelves

(Available in all species)



SMALL BLOCK



LARGE BLOCK

Caming

Ask your Sales Rep for available caming options on select doors

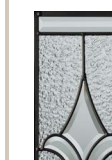

PATINA



ZINC



BRASS



4912 | shown in fir

FIR



4917 | Flat
PASADENA



4901 SL



4936 | Flat
TRADITIONS

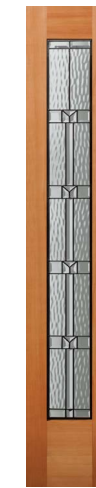

4901 SL



4933 | Flat
TRADITIONS



4901 SL



4912 | Flat
TRADITIONS



4901C SL



4912 | Flat
PASADENA



4901C SL



4917 | Flat
TRADITIONS



4901 SL

WHITE OAK

MAHOGANY



4912 | Flat
TRADITIONS



4901C SL



4912 | Flat
PASADENA



4901C SL



4933 | Flat
TRADITIONS



4901 SL

CHERRY



4936 | Flat
TRADITIONS



4901 SL

Caming

Ask your Sales Rep for available
caming options on select doors

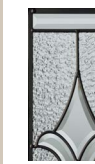

PATINA



ZINC



BRASS

Discover the timeless beauty of Craftsman doors. Inspired by the architectural designs of the Arts and Crafts movement, this door style is defined by signature glass panels and classic clean lines. Choose a Craftsman door for lasting style and uncompromising quality.



FIR



4617 | Flat

4612 | Flat

4612 SL

4632 | Flat

4344 | Flat

FIR



4633 | Flat

4661 | Raised

4662 | Raised

4662 SL



4662 | Flat

4662 SL

4662A | Flat

4662A | Raised

4667 | Flat



4663 | Raised

Glass

In-stock glass options vary by style



Dentil Shelves

(Available in all species)

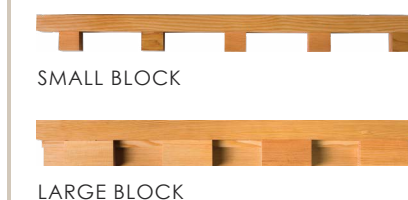



4662 with 4662 SL | shown in knotty alder

KNOTTY ALDER



4612 | Flat

4662 | Flat

4662 SL

4662 | Raised

4662 SL

4662A | Raised



4662 | shown in knotty alder

One look at our Country Sash and Prairie Mission doors and you will immediately notice the high-quality handcrafted workmanship. Both welcoming and charming, these door styles allow for an abundance of natural light and room expanding views. Select these classic door styles to add character and value to your home's exterior.

KNOTTY ALDER



4182 | Raised



FIR



4108 | Flat



4182 | Raised



4144 | Raised



4702 SL



4482 | Flat

FIR



4661V | Raised
BEADED



4661V SL



4661VA | Raised
BEADED



4644 | Raised



4697 | Flat



4982 | Flat



4982V | Raised
BEADED



4703V SL



4982VA | Raised
BEADED



4944 | Raised



412V | Raised
BEADED



4704V SL



412VA | Raised
BEADED

Glass

In-stock glass options vary by style



SATIN
ETCH



LOW-E

Dentil Shelves

(Available in all species)



SMALL BLOCK



LARGE BLOCK

Multiple sizes, glass, and sticking options available. Contact your Sales Representative for more information. Doors are shown with clear coat finish (except primed).

Let the light in with elegant French doors. Graceful, stunning, and strong, French doors offer light-filled and room-expanding entryway or patio possibilities. Available in a number of styles, simply pair the wood and glass treatment of your choice for a truly sophisticated look.



4501 | shown in knotty alder

KNOTTY ALDER

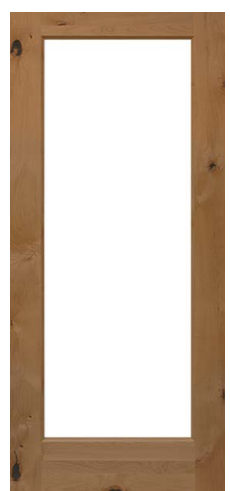

4501



4701 SL



4510



4512 - 8'

FIR

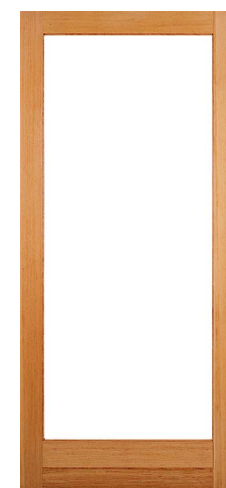

4501



4701 SL



4621 | Raised



4624 | Raised



4110 | Raised

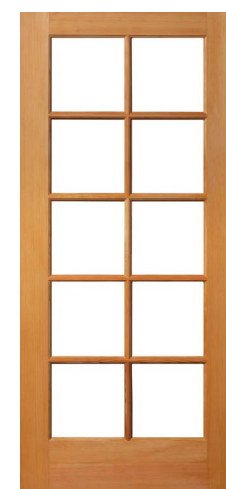

4510



4705 SL



4597 | Raised



4797 SL

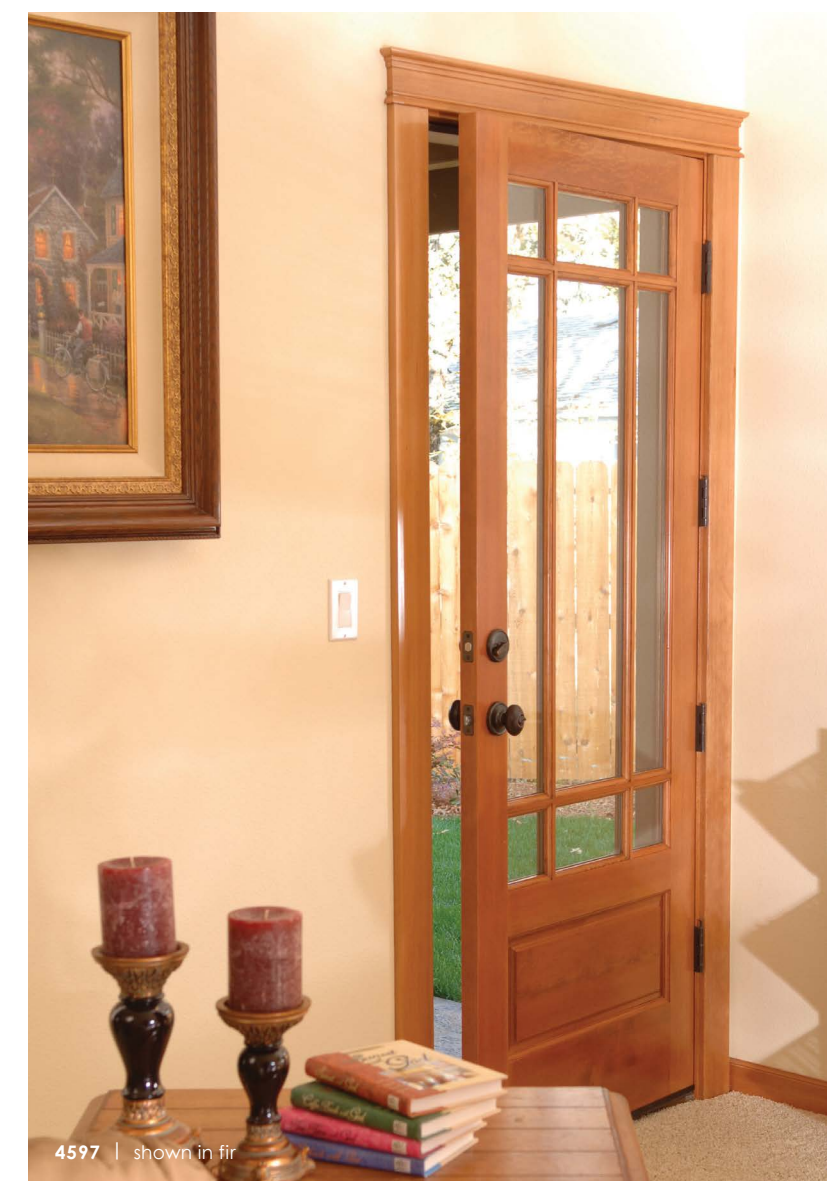

4597 | shown in fir

Create a magnificent first impression with traditional panel door designs. The perfect choice for a clean and classic look, Traditional doors are crafted in a variety of architectural styles and available in knotty alder, fir or primed wood. Durable and elegant, these beautiful entries can be hung as single or double doors.

KNOTTY ALDER



4082 | Flat



4701 SL



4082 | Raised

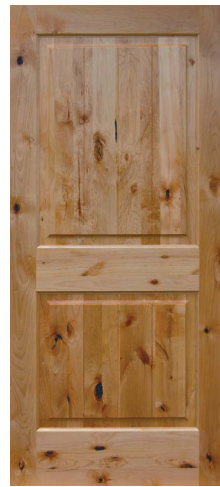

4082V | Raised



4612 SL



4082A | Raised



4082VA | Raised



4033 | Flat



4055 | Raised

8/0 includes 6 panels

Optional Accessories

- SPEAKEASY KIT
- ROUND CLAVOS NAILS





4130 | shown in fir

FIR



4020 1P | Flat



4082 | Flat



4030 | Flat



4033 | Flat



4040 | Flat



4044 | Raised



4085 | Flat



4055 | Flat



4055 | Raised



4130 | Raised



4132 | Raised



4134 | Raised

Multiple sizes, glass, and sticking options available. Contact your Sales Representative for more information.
Doors are shown with clear coat finish (except primed).



28
DECORATIVE FRENCH

Light-filled doorways featuring the added privacy and beauty of decorative glass.



40
BIFOLDS

Beautiful wood closet doors designed for lasting performance and durability.



32
CLEAR FRENCH

Accentuates any room with natural wood construction and elegant clear glass finishes.



44
BARN DOORS

Versatile sliding doors perfectly suited for a rustic or industrial statement piece.

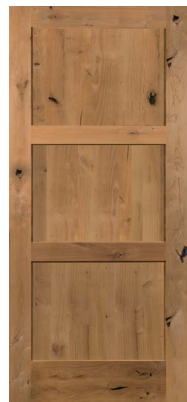

34
TRADITIONAL

Classic interior doors for a consistent and sophisticated look that never goes out of style.



50
FIRE-RATED 🔥

Safety blends seamlessly with style, functionality, and superb craftsmanship.



Enhance the doorways of your home with elegant French doors. This sophisticated door style is offered in a variety of wood species to perfectly match your existing home interior. Pair your French doors with decorative or clear glass for a customized look that is all your own.

PRIMED

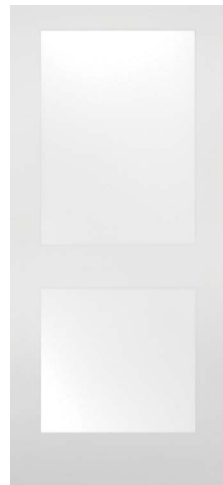

1502
SATIN ETCH

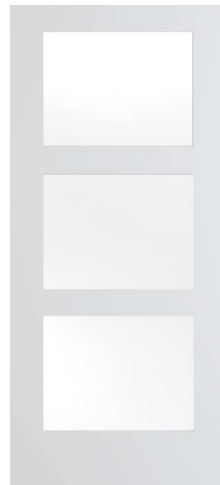

1503
SATIN ETCH

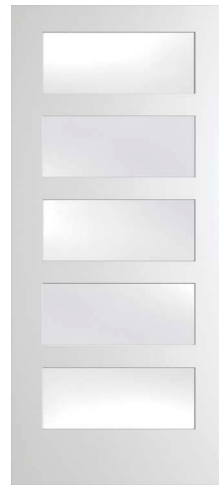

1505
SATIN ETCH

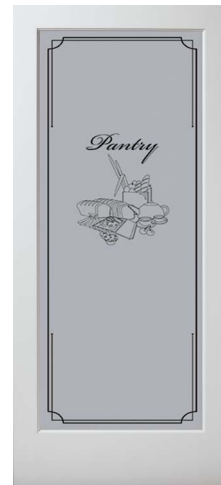

1501
PANTRY (CURSIVE)



1501
PANTRY (PRINT)



1501
MIRROR



1501
WHITE LAMI



1501
SATIN ETCH



1501
RAIN



1501
NARROW REED

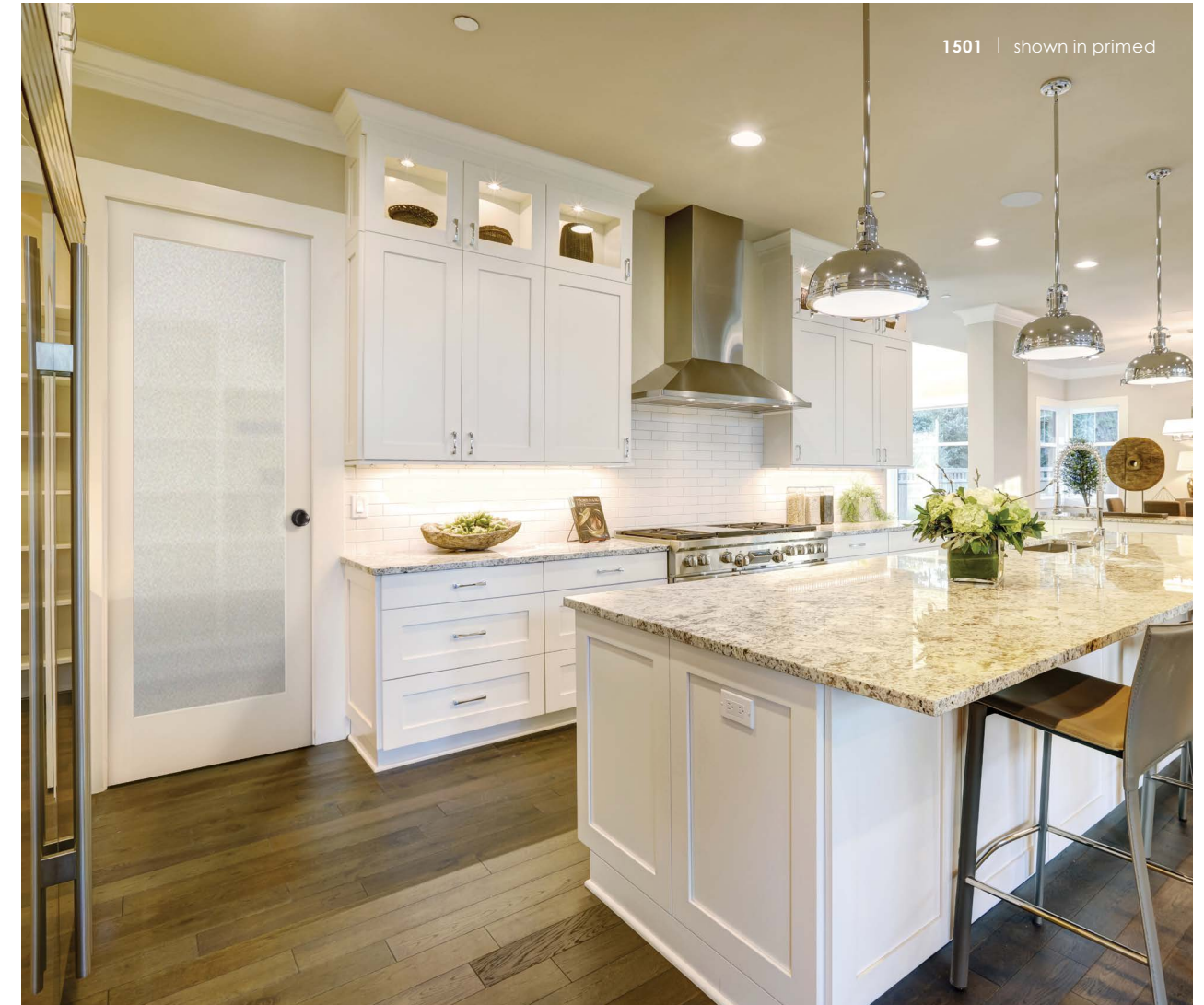

1501
SEEDY BAROQUE



401 - 8' | Flat
SATIN ETCH



401 - 8' | Flat
SEEDY BAROQUE

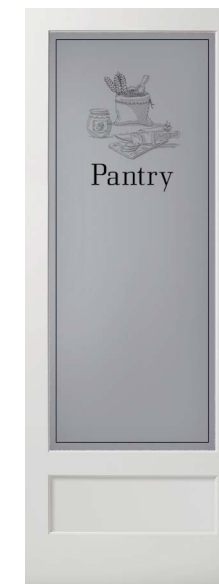

401 - 8' | Flat
PANTRY (PRINT)



KNOTTY ALDER



1501
SATIN ETCH



1501
RAIN

KNOTTY ALDER



1501
PANTRY (PRINT)



1501
SEEDY BAROQUE



1120
MAGNETIC CHALKBOARD

HEMLOCK



1501
SEEDY BAROQUE



1501
SATIN ETCH

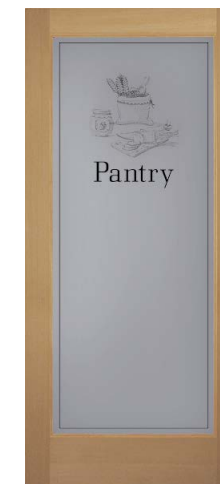

1501
PANTRY (PRINT)

FIR



1501
SATIN ETCH



1501
RAIN



1501
PANTRY (PRINT)



1501
SEEDY BAROQUE



1501
NARROW REED

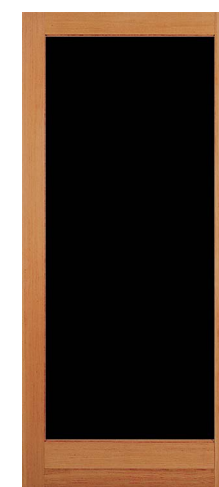

1120
MAGNETIC CHALKBOARD



HEMLOCK

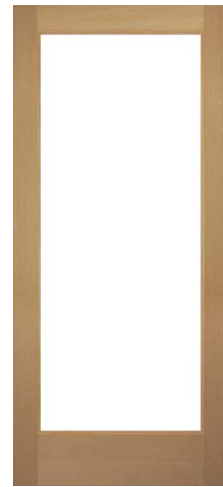

1501

FIR

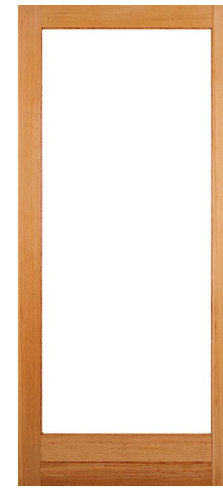

1501



1510



1515

CLEAR PINE

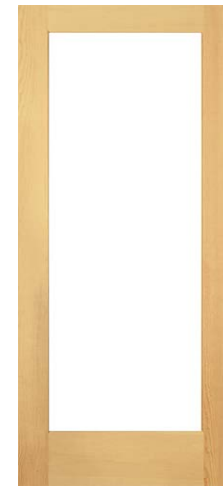

1501



1510



1515

PRIMED

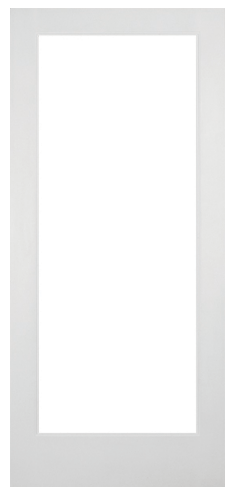

1501

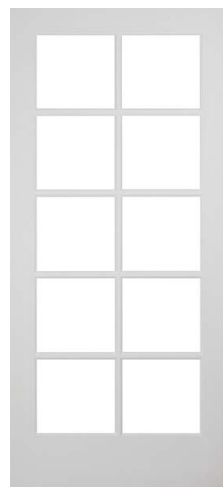

1510

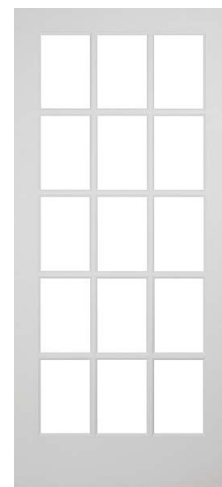

1515

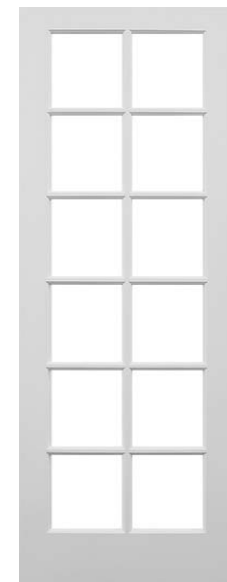

1512-8'

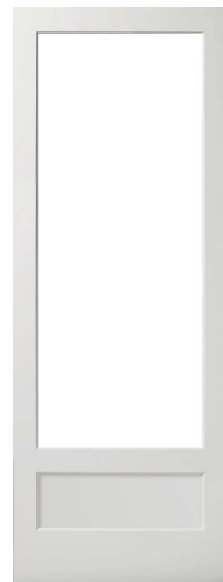

401-8' | Flat

KNOTTY ALDER

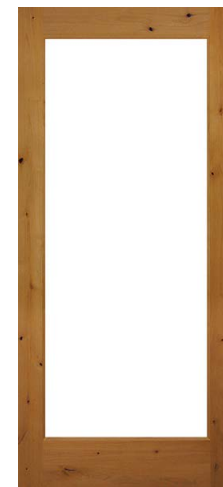

1501



1510



1512-8'

Unify your interior design with the lasting look of Traditional door styles. Our selection of natural wood doors create a cohesive finishing touch. Choose from raised or flat panel designs in a variety of wood species for a timeless look to be enjoyed for years to come.



55 | shown in knotty alder

KNOTTY ALDER



82 | Flat



82 | Raised



82V | Raised
V-GROOVE



82A | Raised



82VA | Raised
V-GROOVE



33 | Flat



30 | Flat



55 | Flat
8/0 includes 6 panels

CLEAR PINE



82A | Raised



44 | Raised



66 | Raised



732
LOUVER / PANEL



730
LOUVER / LOUVER



PRIMED



20 | Flat 82 | Flat 82 | Raised 82A | Raised 82VA | Raised
V-GROOVE

PRIMED



30 | Flat 33 | Flat 55 | Flat 66 | Raised

HEMLOCK



732 LOUVER / PANEL 730 LOUVER / LOUVER 82 | Raised 82 | Flat



30 | Flat 33 | Flat 55 | Flat 66 | Raised

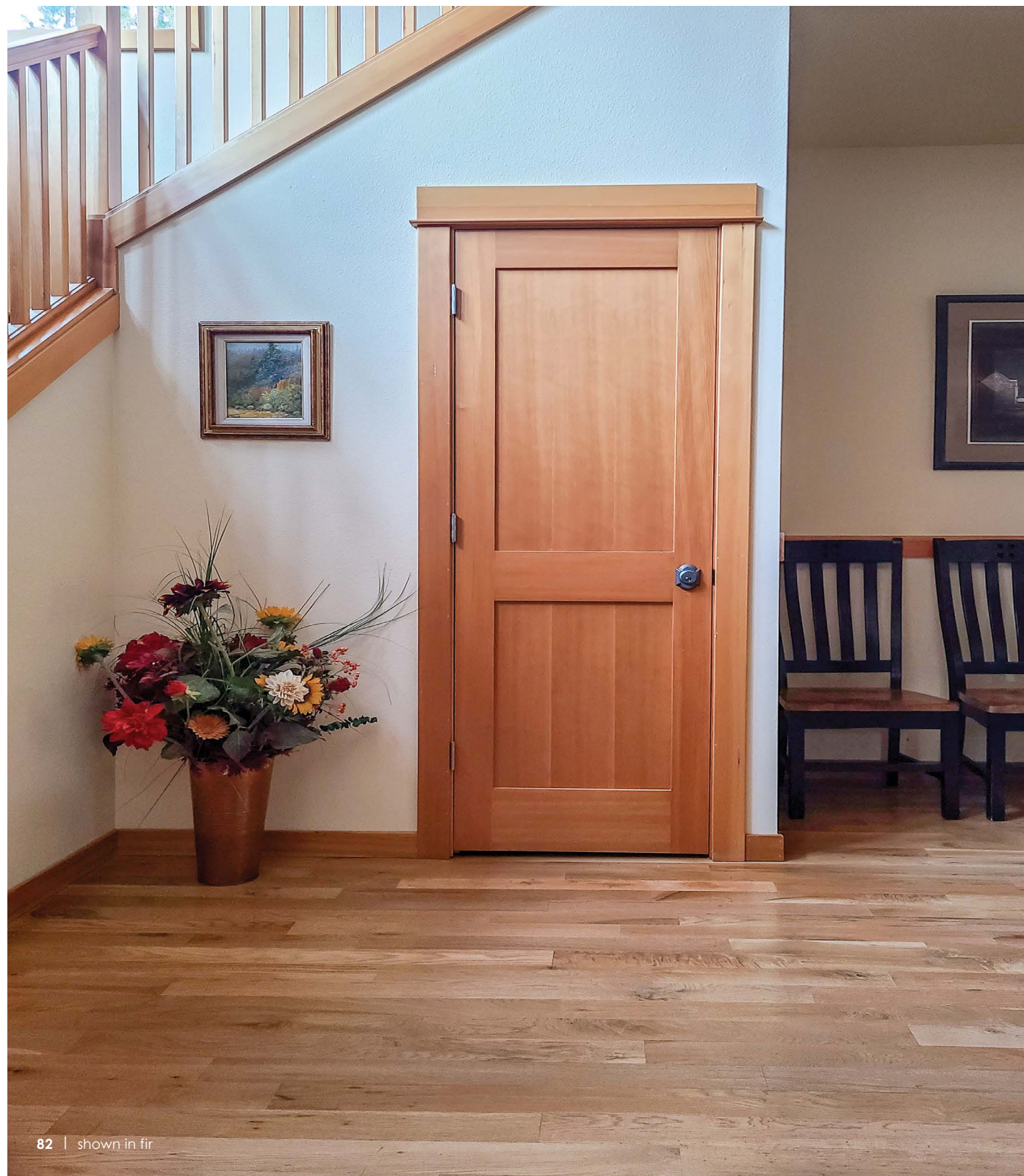

82 | shown in fir

FIR



20 | Flat



82 | Flat



82 | Raised



82A | Raised



30 | Flat



33 | Flat



44 | Raised



55 | Flat

8/0 includes 6 panels



55 | Raised



66 | Raised

KNOTTY PINE



82V | Raised
V-GROOVE



82VA | Raised
V-GROOVE



44 | Raised



66 | Raised

Multiple sizes, glass, and sticking options available. Contact your Sales Representative for more information.
Doors are shown with clear coat finish (except primed).

Beautiful and functional, our Traditional wood bifold doors provide classic styling and durable construction that stands up to everyday use. Available in panel and louver designs, bifold doors are the perfect solution for full-sized closet openings, laundry rooms, storage areas, and more.



CLEAR PINE



82 BF | Raised 82A BF | Raised 66 BF | Raised 732 BF LOUVER / PANEL 730 BF LOUVER / LOUVER

FIR



20 BF | Flat 82 BF | Flat 33 BF | Flat 55 BF | Flat



82 BF | Raised 82A BF | Raised 66 BF | Raised

KNOTTY PINE



82 BF | Raised 82V BF | Raised V-GROOVE 82VA BF | Raised V-GROOVE 66 BF | Raised

Multiple sizes, glass, and sticking options available. Contact your Sales Representative for more information. Doors are shown with clear coat finish (except primed).



82 BF | shown in primed

PRIMED



20 BF | Flat 82 BF | Flat 33 BF | Flat 30 BF | Flat 55 BF | Flat

PRIMED



82 BF | Raised 82A BF | Raised 82VA BF | Raised 66 BF | Raised

KNOTTY ALDER



732 BF LOUVER / PANEL 730 BF LOUVER / LOUVER 82 BF | Raised 82V BF | Raised V-GROOVE 82A BF | Raised



82VA BF | Raised V-GROOVE 82 BF | Flat 33 BF | Flat 30 BF | Flat 55 BF | Flat

Turn any doorway into a statement by adding a sliding barn door. This versatile door style adds charm and character while making the most of your available space. Customize your barn door to match your style, whether you prefer the rustic look or a more minimalist aesthetic.

Optional Accessories

Barn Track Hardware Kit



**LIKE A DOOR STYLE
BUT WANT IT AS A
BARN DOOR?**

Order a standard door in a wider size or have Rogue Valley Door custom build your barn door in a variety of species and designs.



20V | shown in knotty alder

KNOTTY PINE



20V
V-GROOVE



201-20V
(TWO-SIDED)



201V
V-GROOVE (REVERSIBLE)

KNOTTY ALDER



20V
V-GROOVE



201-20V
(TWO-SIDED)



201V
V-GROOVE (REVERSIBLE)

Multiple sizes and sticking options available. Contact your Sales Representative for more information.
Doors are shown with clear coat finish (except primed).



PRIMED



20 | Flat



20V
V-GROOVE



201V
V-GROOVE (REVERSIBLE)



202V
V-GROOVE



55 | Flat

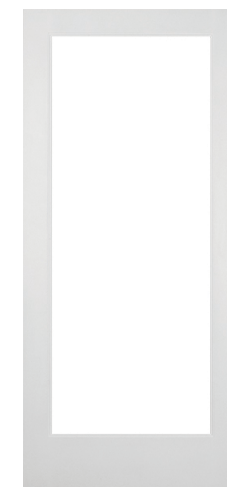

1501

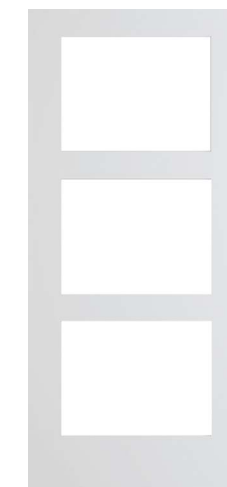

1503



1505

Glass
In-stock glass options
vary by style



SATIN
ETCH



LOW-E

The CS Cavity Slider is a practical solution for those areas where there is not enough space for a swinging door. In addition to its space saving attributes in restrooms, hallways and laundries, it can be used with confidence for architectural feature openings around your project.

POCKET FRAME SYSTEMS

- Structurally robust due to its construction from aluminum extrusions
- Easy to assemble and install
- Pocket frame accommodates 1-3/8" and 1-3/4" doors up to 4'0" x 8'0" (special order for 9' & 10' available)
- Can be cut down to size on site
- Suitable for residential and commercial projects (meets Type 1 construction code without any combustible materials)

QUALITY SLIDING DOOR HARDWARE

The CL200 is a durable range of sliding door hardware suitable for residential, commercial, and hospitality applications. Privacy handles incorporate a patented magnetic latching system*, ensuring a smooth locking action.



STANDARD CL200 RANGE

- Two face plate widths available
- Handles can be adjusted to suit doors from 1-3/8" to 1-1/2" or 1-5/8" to 1-3/4" thick
- Integrated snib button allows more space in side pull
- Handles are not handed
- Easy-to-follow instructions

PREMIUM CL400 MAGNETIC

- Configurations include Passage, Privacy, Bi-Parting and Key Locking
- Door slides flush back into the pocket
- Suits doors from 1-3/8" to 2-1/4" thick
- Available in a range of finishes
- Non-magnetic version available

CS CavitySlider™ FEATURES

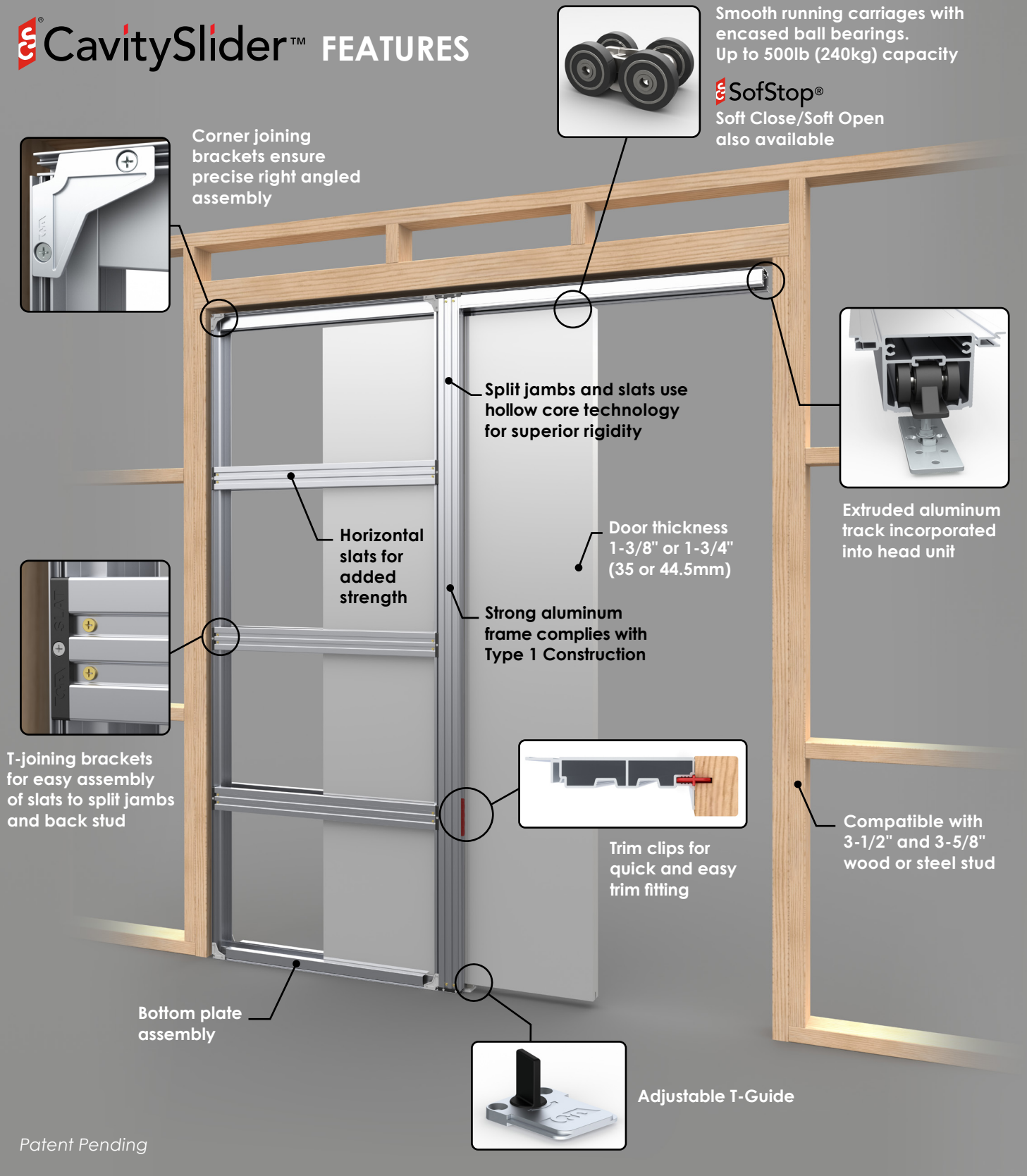

- Cycle Tested 1 Million Openings
- ADA Compliant
- Available with SofStop®
- Single or Bi-Parting Units
- Maximum Door Weight 500 lb
- Easy Assembly

Fire-rated doors play an integral role in the safety of your home and loved ones. Our fire-rated doors are most commonly used as a passage door between the house and adjacent garage (as required by most building codes). The doors on these pages are certified by an authorized testing agency and have a 20-minute fire rating.* In addition to their safety attributes, our doors are available in a variety of styles and species to match your desired look.



4082AF | shown in fir

FIR



4020F 1P | Flat



4082F | Flat



4082F | Raised



4082AF | Raised



4033F | Flat



4030F | Flat



4044F | Raised



4055F | Flat



4055F | Raised



4130F | Raised



4033F | shown in primed

PRIMED



4020F 1P | Flat 4082F | Flat 4082F | Raised 4082AF | Raised 4082VAF | Raised
V-GROOVE

PRIMED



4033F | Flat 4030F | Flat 4055F | Flat
8/0 includes 6 panels 4130F | Raised

KNOTTY ALDER



4082F | Raised 4082VF | Raised
V-GROOVE 4082AF | Raised



4082VAF | Raised 4082F | Flat 4033F | Flat
V-GROOVE



4082AF | shown in knotty alder

Making Doors That Will Last a Lifetime

Artistry, innovation, and precision are the trademarks of Rogue Valley Door. From meticulously crafted decorative doors to classic traditional entrances, our premium collection of wood doors stand the test of time and welcome generations to come.

Rogue Valley Door proudly features products made in America using the finest materials, state-of-the-art milling technology, and expert craftsmanship. We invite you to turn the pages and discover the lasting beauty and unsurpassed durability of our wood door collection.

Looking for something unique to reflect your personal style? If you can imagine it, Rogue Valley Door can build it. See page 58 to learn more about the countless customizable options from Rogue Valley Door.



- **Made in the U.S.A.**
Rogue Valley doors are proudly made in America using only domestically manufactured components.
- **Variety of Wood**
More than 40 wood species to choose from, including doors constructed of multiple woods – finished, stain-ready or primed to paint.
- **Variety of Glass**
Rogue Valley Door gives you a choice of 23 different glass treatment options, custom etched glass, and the Cielo Series.
- **Fire Doors**
Available in a variety of species, fire doors are made with 20, 45, 60 and 90-minute fire-resistance ratings.
- **Substantial Veneer**
While a majority of imported doors use veneers as thin as 1/50 of an inch, Rogue Valley Door uses nothing less than sturdy 1/16" veneer on all stiles and rails.
- **Custom Lockset Prep**
Custom pre-hanging and machining available for fire doors, shaped doors, radius top doors, commercial doors, and more.



Imagine It and We Can Build It

Your home is a reflection of your lifestyle. From outdoor landscaping to interior design, it's your imagination that turns a house into a home. Enhancing it with custom doors makes a bold statement and puts the finishing touches on your creation.



Explore the Countless Possibilities of Customizable Exterior and Interior Doors*

Considering Rogue Valley Door offers a multitude of custom styles and shapes using a wide variety of wood species and glass treatments, the possibilities are endless. Whether you're an architect, builder or homeowner, you have the opportunity to make one of our premium wood doors your own. If you can imagine it, we can build it.

Open the Door to Your Creativity

Inspired to create a custom door design? Rogue Valley Door provides all of the creative tools to design doors as unique as you are.* From initial sketches, we generate a precise CAD drawing. From there, the design is sent along to our craftsmen. With great pride and attention to detail, we incorporate the materials you choose, build it to your precise specifications, and have it ready to ship within weeks.



How to Design Your Custom Door

- 1 OPENING DESIGN**
Begin by choosing a door design or custom shape, handcrafted to your specifications.
- 2 DOOR STYLE**
Customize your door with unlimited panel and glass combinations.
- 3 SPECIES**
Choose from more than 50 wood species for your custom door or mix and match multiple species for a unique look.
- 4 GLASS STYLE**
Invite natural light into your home with an assortment of custom glass textures and shapes.
- 5 PANEL & STICKING**
Complete the look with complementary panel and sticking profiles.

1 OPENING DESIGN

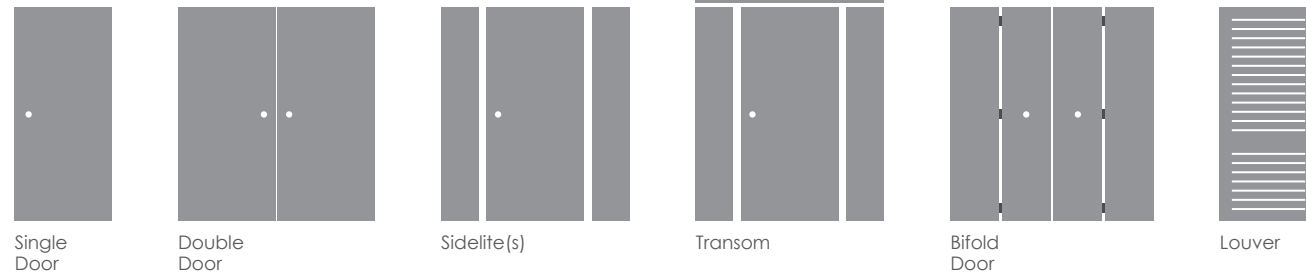

Single Door Double Door Sidelite(s) Transom Bifold Door Louver

2 DOOR STYLE

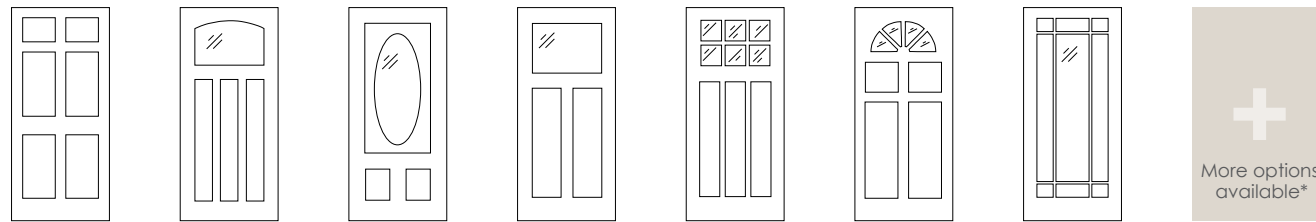

3 SPECIES

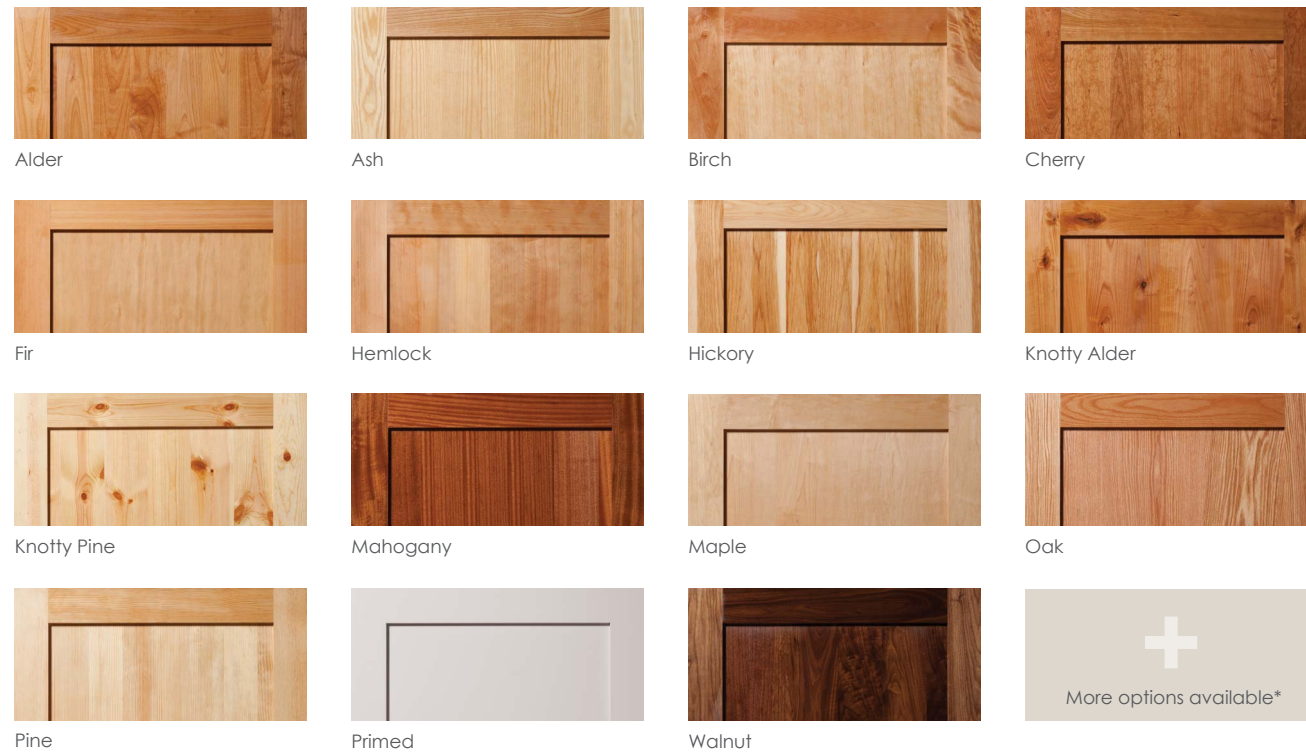

4 GLASS STYLE

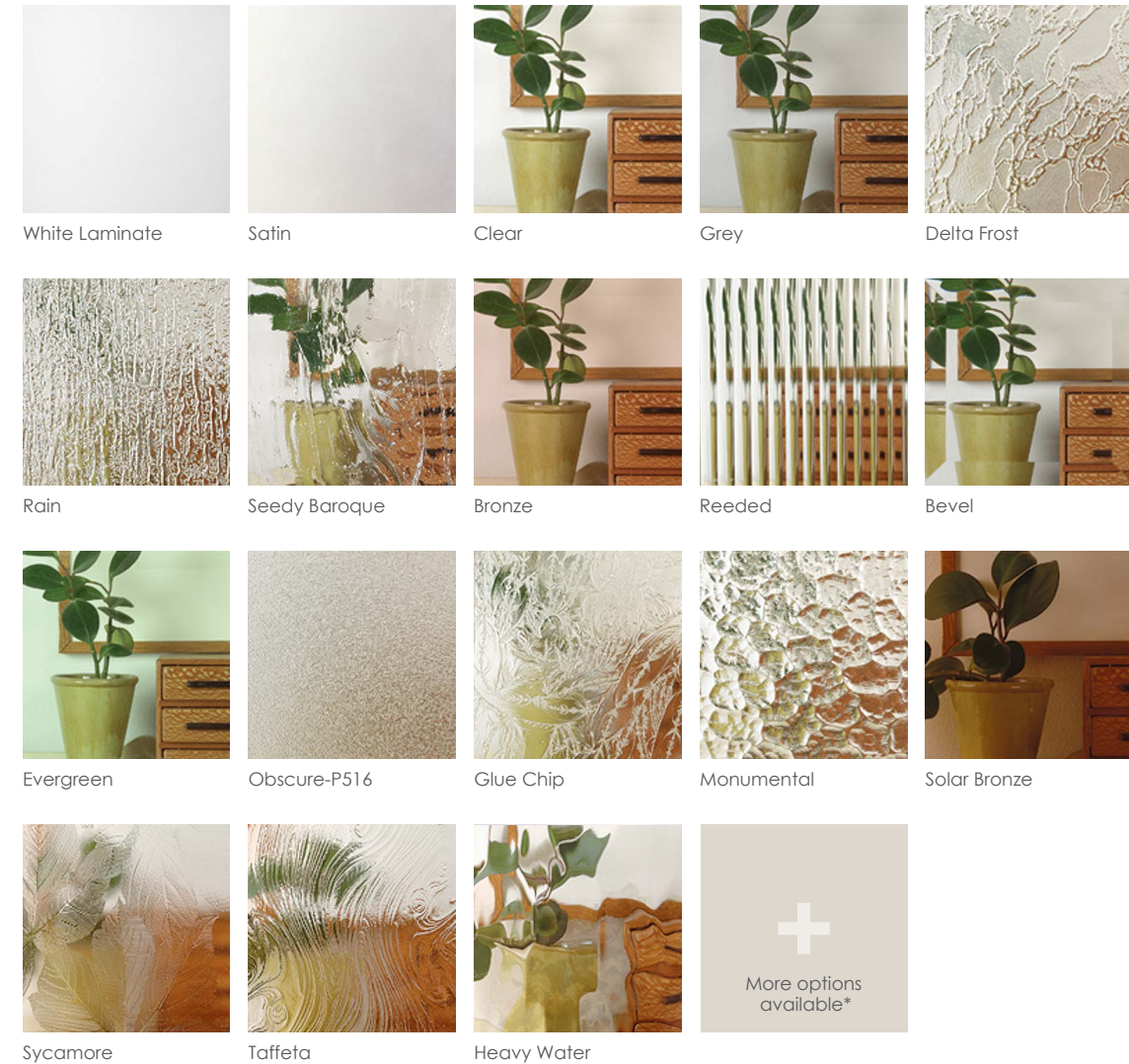

5 PANEL & STICKING OPTIONS

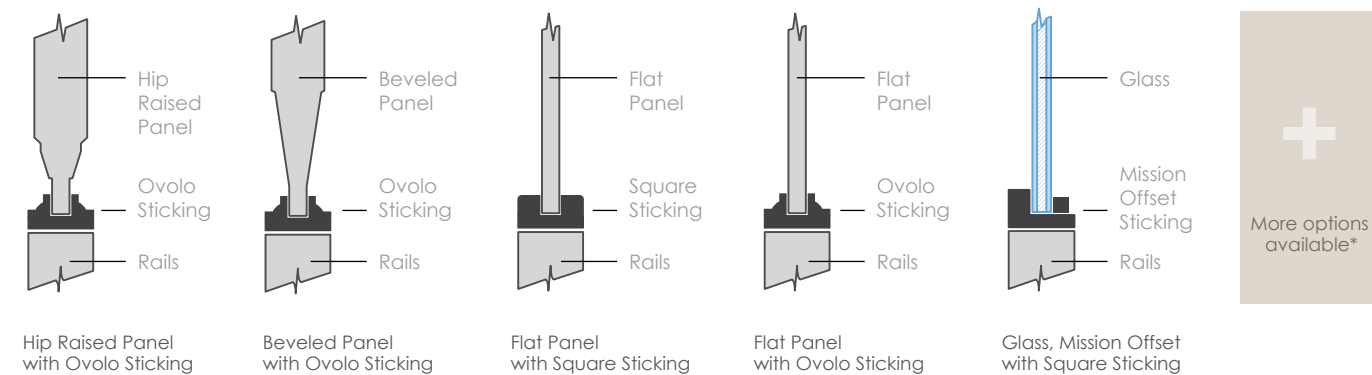

Handling & Storage

1. Deliver doors in a clean truck and under cover.
2. Do not deliver or install doors until foundations, concrete floors, and plaster or texture walls are completely dry.
3. Allow doors time to acclimate to the conditions at the job site prior to installation.
4. Never subject doors to abnormal heat, dryness or humidity for prolonged periods (i.e. forced heat).
5. Store doors lying flat on a level surface above the ground in a dry, well-ventilated building and keep covered. Don't stack doors on end.
6. If the doors are to be stored on the job site, the entire door including top and bottom edges must be sealed with a clear or pigmented based sealer to prevent moisture absorption. All six sides of the door must be properly sealed including all edges of any cut openings (speak easy, mail slot, pet door, vent, peep site, etc.) for warranty to apply.
7. To keep doors protected, use clean gloves and equipment. Cover doors, but allow for air circulation. Carry, do not drag doors over any surface.

Important Note:

Panels of stile and rail doors are engineered to float so they can move with changes in climate without causing stress. Make sure these components are aligned before finishing. You can correct alignment by carefully moving the panel with a wood block, rubber mallet, and a soft touch. Components that have shifted and must be aligned are not considered "defects" according to the warranty.

Fitting & Hanging

1. When hanging a door, allow adequate clearance for swelling of door and frame in extremely damp weather.
2. Use designated sizes to avoid cutting door width. For trimming ends, we recommend a sharp, fine-tooth saw.
3. Be careful not to impair structural strength of door when fitting hardware or special features. To prevent distortion, set hinges in a straight line. Use three hinges on doors 7' or less; four hinges on doors over 7' high. Jambs and stops must be square and plumb.
4. Protect outward swinging doors that are exposed to the elements. An adequate overhang is strongly recommended for exterior doors. A general rule of thumb for an overhang is to measure height from porch to overhang and divide the distance in half. That measurement would be a minimum overhang width recommended.
5. Immediately after fitting or cutting, and prior to weatherstripping and hanging any door, give the entire surface (including all edges) two coats of paint/stain, varnish or a quality sealer to prevent moisture absorption.
6. To minimize heat loss and reduce energy costs, use any good weatherstrip on exterior doors.
7. Damage incurred due to extreme temperature buildup when a storm door is used is not considered a defect.

Important Note:

OrePac reserves the right to make product improvement changes in specifications, materials and construction details.

Preparation & Finishing

1. Inspect door carefully for defects before finishing.
2. All wood doors supplied by OrePac require sanding and prep prior to finish. The amount of sanding will depend on the expected appearance after finish.
3. Remove all dust with a tack cloth before beginning to apply finish.
4. Hang the door prior to finishing, then remove to finish properly.
5. Apply finish to the door immediately after fitting and hanging, but never during or immediately after high periods of moisture.
6. The door should be finished while lying flat for maximum performance of finishing.
7. Use solvent-based paints, sealers and stains, or when applicable, high-quality water-based paints or stains, and follow the paint/stain manufacturer's directions. Apply finish to all surfaces including top and bottom edges, and the edges of all cut openings (speak easy, mail slot, vent, pet door, peep site, etc.). Dark color finishes should not be used on doors exposed to prolonged direct sunlight. The heat buildup may cause warping, veneer checks or separation.
8. To stain the door: Apply a stain and sealer combination as recommended by the paint/stain manufacturer for the type of application (either exterior or interior). The stain or sealer combination will stain the door and seal the surface. Apply three coats of clear top coat, such as varnish or polyurethane. Sand lightly between coats. All exteriors must have ultraviolet (UV) inhibitors in the finish. Do not use solid-based stains as the final finish. These finishes must have three coats of varnish or polyurethane as final top coat.
9. To paint the door: Use a quality solvent-based primer, followed by three coats of a good exterior paint recommended by the paint/stain manufacturer to be compatible with the primer. When finishing glazed doors, apply top coats generously to bridge wood and glass. To protect against moisture, lap paint onto glass 1/16". For interior applications, use a quality interior primer followed by two coats of interior latex enamel or solvent-based paint. The door manufacturer and distributor are not responsible for the final appearance of doors finished in the field. It is expected that the contractor will make adjustments as needed to achieve the desired results.
10. All finishes will last longer when protected from the direct sun and rain by an overhang or porch. If the door is exposed to the elements, a fine bead of silicone caulk should be used between the glass and sticking or panel and sticking on the door's exterior.

OrePac warranties that each door purchased from OrePac is of good material and workmanship and shall be free of defects which render such door(s) unserviceable or unfit for ordinary recommended use.

One-Year Exterior Door Warranty

Doors used in an exterior application (with controlled climate conditions on one side) shall carry a one-year limited warranty from the date of purchase from the dealer. This warranty applies only to doors that have been properly finished, sealed, and hung in a location protected from direct exposure to sun and rain, under normal conditions. For more details, please refer to the Wood Door Installation Guide.

Five-Year Interior Door Warranty

Doors used in an interior application (with controlled climate conditions on both sides) shall carry a five-year limited warranty from the date of purchase from the dealer. This warranty applies only to doors that have been properly finished, sealed, and hung. The five-year warranty applies only to the original homeowner and is not transferable.

Determining Adequate Overhang

To determine if your door has adequate overhang, measure up from the bottom of the door to the ceiling and divide that distance by two. The resulting number will be the minimum allowable overhang. If you have a western or southern exposure, you may still receive direct sunlight on the door and a larger overhang will be required.

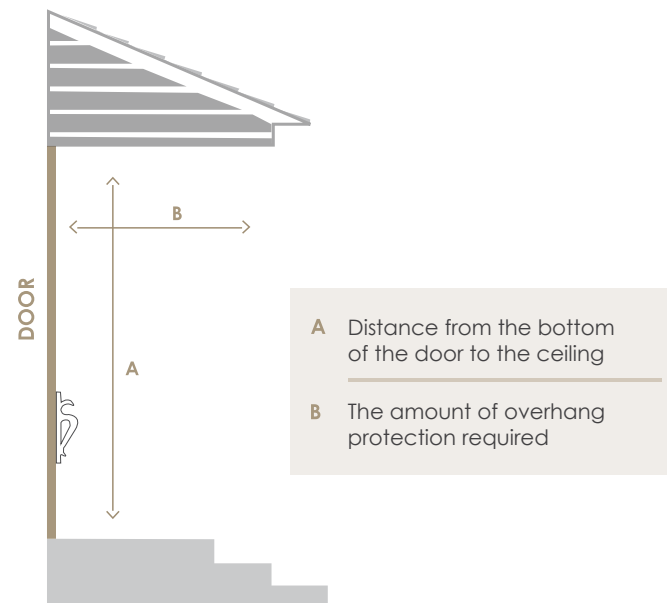

Characteristics Excluded from Warranties

The following are not defects in the workmanship or material and are not covered by this written warranty:

1. Damage caused by failure to comply with the "Care & Finishing" instructions.
2. Warp of less than or equal to 1/4" in the plane of any door 3' x 7' or smaller.
3. Defect caused by a warped or bowed jamb/frame unit or improper installation.
4. Natural variations in the color or texture of the wood.
5. Failure to properly seal and maintain the integrity of the door finish. All six sides, and the edges of any cut openings (speak easy, mail slot, pet door, vent, peep site, etc.) must be sealed immediately after fitting and hanging.
6. Panel misalignment or shrinkage.
7. Rail expansion due to climate conditions.
8. Damage caused by extreme temperature buildup where a storm door is utilized.
9. Failure to perform normal homeowner's maintenance, including but not limited to, reapplying topcoat on a yearly basis.
10. The performance or appearance of finishes applied.

Limitation of Liability

The liability of OrePac is expressly limited to the replacement or repair of the door or a refund, in full, of the original purchase price. OrePac shall not be liable for any special, consequential indirect or incidental damages based upon breach of express or implied warranty, breach of contract, negligence, strict tort or any loss of profits, loss of savings or revenue, loss of use of the door or structure in which the door is installed, cost of any substitute doors, claims by third parties including subsequent purchasers of OrePac's products and injury to property.

This warranty gives you specific legal rights and you may have other rights which vary from state to state.

Additional warranty details and restrictions are available through your OrePac representative.

Builders
CHOICE

CUSTOM DOORS created by

ROGUE VALLEY
Door



WARNING: Cancer and Reproductive Harm
www.P65warnings.ca.gov

